

NS 25



operations **MANUAL**

Overview

How the NS25 Works

Congratulations on your purchase of the Hummingbird NS25. The NS25 uses GPS and sonar capability to determine your position, display it on a map, and provide detailed underwater information.

The NS25 consists of four primary components; the control head, GPS receiver (SAT MAX), card reader and transducer. The control head contains the user controls and display. The GPS receiver receives signals transmitted by the constellation of GPS satellites orbiting the earth. It selects four or more satellites whose position and signal strength provide the most accurate position. From these four satellites, the GPS receiver calculates time, boat position (latitude/longitude), boat speed and direction of travel. The card reader displays electronic map information from the cartridges installed. The transducer is mounted beneath the water surface and converts electrical energy from the transmitter into mechanical pulses or sound waves. The transducer also receives the reflected sound waves and converts them back into digital signals for display on the sonar unit.

GPS

The Global Positioning System (GPS) is a satellite navigation system designed and maintained by the U.S. Department of Defense. GPS was originally intended for military use, however, civilians may also take advantage of its highly accurate position capabilities, typically within +/- 100 meters. This means that 95% of the time you will be within 300 feet of your actual position. Further capabilities are possible with the Differential Global Positioning Systems (DGPS), which operate to refine satellite signal to the most accurate position possible

GPS uses a constellation of 24 satellites that continually sends radio signals to the earth. Your position is determined by receiving signals from four or more satellites and measuring the distance from the satellites to determine your present position.

SONAR

Sonar uses sound waves to determine the presence and location of underwater objects. The time measured between the transmission of the sound wave and the reception of any reflection is used to determine distance. The transmit and receive cycle is very fast. A sound wave can travel from the surface to a depth of 240 feet and back again in less than $\frac{1}{4}$ of a second, so it is unlikely that your boat can "outrun" this sonar signal. Analysis of the reflected signal can also be used to determine location, size, composition, etc.

NOTE: Actual depth capability depends on such factors as bottom hardness, water conditions, and transducer installation. Units will typically read deeper in fresh water than in salt water.

After spending a few minutes with your NS25 on the water, you will see the unit's ability to accurately portray the underwater terrain, suspended targets, GPS position, and your position on a map.

Your NS25 comes with everything necessary for installation and operation on most boats. The transducer included, XT-6-20, is designed for mounting on the transom of the boat (directly exposed to the water). On fiberglass hull boats, this same transducer can be bonded to the inside of the hull. When mounted inside the hull, the sonar signal actually passes through the hull of the boat. Both mounting techniques produce acceptable results on most boats.

Installation

Parts Supplied

Before installing your NS25, please ensure that the following parts are included in the box:

- Control Head
- GPS Receiver
- Transducer with 20 foot cable
- Quick-Disconnect mounting hardware kit
- Control head mounting hardware kit
- GPS receiver mounting hardware kit
- Card reader mounting kit
- Transducer mounting hardware kit
- 6 foot power cable
- 20 foot GPS receiver extension cable
- GPS "Y" cable for NMEA output and GPS receiver input
- Publication kit
- In-dash mounting kit

It is recommended that you install the NS25 components in the following order; 1) GPS receiver, 2) transducer, 3) card reader, then 4) control head.

GPS Receiver Installation

To optimize performance of the GPS receiver, mount it in an area that has full exposure to the sky. The effective area of reception is 10 degrees above the horizon.

Different circumstances determine the mounting method appropriate for your GPS receiver.

If you have...

Then install:

An existing antenna stem with
Standard 1" – 14 thread

Stem Mount
(Existing Stem – Fig. A)

Under location access with
Deck less than 3/8"

Deck Mount
(Thin Deck- Fig. B)

Under location access with
Deck greater than 3/8"

Deck Mount
(Thick Deck – Fig C)

No access under mounting

Deck Mount

Location

(Cable Side – Fig. D)

Note: When routing the GPS receiver extension cable, ensure the correct connector end is routed to the GPS receiver and control head.

An Existing Stern with 1" – 14 Thread

Follow these steps to stem mount the GPS receiver:

1. Determine best location, then route 20 foot cable to mounting location. Mark it and drill a ½" hole.
2. Place stem over ½" hole and mount with screws provided with stem.
3. Place lock nut on stem, thread down at least half way.
4. Route GPS receiver cable through stem. Continue through surface.
5. Thread GPS receiver on stem. Tighten lock nut with crescent wrench to secure GPS receiver head.
6. Connect extension cables to GPS receiver cable.

Under Location Access with Deck Less Than 3/8"

Follow these steps to deck mount the GPS receiver routing the cable down through the mounting surface:

1. Determine the best location, then route the 20 foot cable from control head to mounting location.
2. Mark mounting location and drill a 1" hole.
3. Insert mounting bolt through 1" hole from lower side of the mounting surface.
4. Place gasket over mounting bolt, route GPS receiver cable down through hole, then secure in place.
5. Connect extension cable to GPS receiver cable.

Under Location Access with Deck More Than 3/8"

Follow these steps to deck mount the GPS receiver routing the cable down through a thick deck:

1. Determine the best location, then route the 20 foot cable from control head to the mounting location.
2. Place mounting flange over mounting location and mark through holes for drilling. Center hole and three mounting holes.
3. Remove flange and drill a ½" hole and three 9/64" holes.

4. Assemble flange, bolt, and gasket, then place over ½" hole. Secure in place with #8 x 5/8 flat head screws.
5. Position the GPS receiver with cable through hole, then secure in place.
6. Connect extension cable to GPS receiver cable.

No Access Under Mounting Location GPS receiver routing the cable to the side.

1. Determine the best location, then route the 20 foot extension cable from control head to mounting location.
2. Place flange over mounting location and mark through the three mounting holes for drilling.
3. Remove flange and drill holes using a 9/64" drill bit.
4. Break out the marked tab on the bottom side, outer rim of the flange.
5. Preassemble the flange, mounting bolt, and gasket with the GPS receiver, routing cable through all components; tighten GPS receiver until its base is in contact with the gasket.
6. Secure flange with #8 x 5/8 flat head screws. To access all screws you will need to rotate the GPS receiver. When finished, secure tightly.
7. Determine a hole location where access for cable routing is available.
8. Drill a ½" hole at this location and route the cable through the hole.
9. Install escutcheon plate at this location with #8 x 5/8 flat head screws.

INSTALLATION PREPARATION

PARTS SUPPLIED

PARTS SUPPLIED

Before installing your new Humminbird fishfinder, please ensure the following parts are included in the box:

- Fishfinder
- Transducer with 20' (6m) of cable and mounting hardware kit
- Mounting system and mounting hardware kit
- 6' (2m) power cable
- Publications kit

If any of these items is missing, call our Customer Support Hotline.

ACCESSORIES

Humminbird offers a wide assortment of accessories that complement and expand the capability of your new fishfinder. These accessories are designed with the same high standards and are backed by the same one-year warranty. The Humminbird Accessory catalog included with your unit contains descriptions of the many accessories available and ordering information. All Humminbird accessories are available through your full-service Humminbird dealer or factory direct through our number listed in the Customer Support section.

INSTALLATION OVERVIEW

Your Humminbird fishfinder consists of two primary components to install: the control head and the transducer.

The control head contains the sonar transmit and receive circuitry, as well as the user controls and display. It should be installed in a location that provides access to the controls and visibility while in use. The control head mounts on a quick disconnect mounting system that swivels and tilts providing flexibility for viewing from almost anywhere on the boat.

The transducer converts electrical energy from the transmitter into mechanical pulses or sound waves. The transducer also receives the reflected sound waves and converts them back into electrical signals for display on the control head. It should be installed in contact with the surface of the water in an area that has smooth waterflow- usually on the transom of the boat. There are several mounting options for the transducer. Review the following section to determine the method that works for you and your boat.

INSTALLATION PREPARATION

INSTALLATION OVERVIEW

Determining How to Mount the Transducer

Your Humminbird fishfinder includes a standard transducer. This transducer can be mounted on the transom of the boat or bonded to the inside of a fiberglass hull boat.

The transom installation, which is the most widely used, places the transducer on the outside of the boat hull. This technique produces the least signal loss, and provides a way to adjust the transducer after installation. The mounting hardware included is designed to protect both the boat and the transducer should the boat strike debris in the water or when trailering.

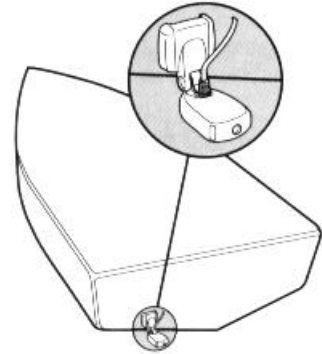

Transom Mounted Transducer

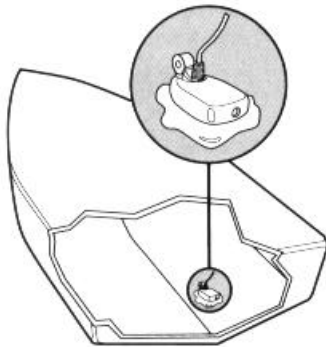

Inside the Hull Mounted Transducer

As an alternative to transom mounting, it is possible on many fiberglass-hulled boats to glue the transducer on the inside of the boat hull. Since fiberglass has similar sonar characteristics as water, the sonar signal can pass through the boat hull with minimal loss. The hull of the boat must be single layer construction (not double-hulled) Also, any air trapped in the lamination of the fiberglass would prevent the sonar signal from passing through.

Inside the hull installations require no holes be drilled into the boat and through experimentation, high-speed operation comparable to transom mounting can be achieved. Two-part slow cure epoxy (not included) is required to glue the transducer in place.

INSTALLATION PREPARATION

ALTERNATE MOUNTING METHODS

ALTERNATE TRANSDUCERS AND MOUNTING METHODS

Your Humminbird fishfinder comes with everything necessary for installation and operation on most boats. However, there are several situations which may require a different type of transducer. Inboard boats, wood or metal hulls, and sail boats create unique transducer mounting needs. Alternate transducers and mounting methods are detailed below.

Portable Mounting

The standard transducer can be adapted for portable installations with a portable mounting kit available from Humminbird. This accessory adapts your transducer to a suction cup mount for temporary installation on the boat hull or other surface.

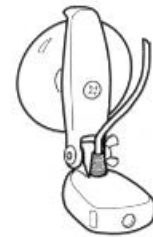

Trolling Motor Mounting

The standard transducer can also be adapted to mount on most trolling motors using a different accessory kit. This accessory includes a bracket and hose clamp that allows mounting the transducer to the body of most trolling motors.



Thru-Hull Mounting

Thru-hull transducers install through a hole drilled in the hull of the boat. Larger boats or boats with inboard motors create turbulence that make transom mounting ineffective. Also, hulls that are very thick or are double layered, or made from materials such as wood or metal, (which do not conduct sonar signals) make inside the hull mounting inadvisable.

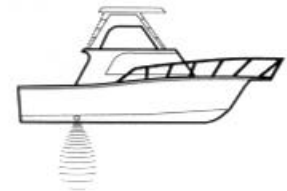

Thru-hull mounting may require the use of a fairing block to level the transducer with the waterline. Also, since special tools and knowledge may be required to perform this type of installation, it is best to refer to a qualified marine technician.

INSTALLATION PREPARATION

TRANSDUCER EXCHANGE

TRANSDUCER EXCHANGE

Other transducers are available as replacements for the standard transducer. You may exchange your new and unassembled transducer for another type by returning it to the address listed in Customer Support. Some transducers may have additional cost. Refer to the Accessory catalog or call Customer Support for information.

BEGINNING INSTALLATION

Now that you have determined the transducer mounting method you can begin installation of your new Humminbird fishfinder. The installation guide included on the next few pages provides detailed step by step instructions for installation of the control head and transducer. For transom mount transducer installations you will need the mounting template included with your manual.

In addition to the parts included you need the following for installation and operation:

- A powered hand drill and various drill bits
- Philips and flat-head screwdrivers
- A ruler or measuring tape
- Pen or pencil
- 12 volt power source (your boat's battery)
- A 1-amp fuse
- A fuse holder (if you are wiring directly to the boat's battery)
- Silicone sealant (for sealing drilled holes)
- 2-part, slow-cure epoxy (for inside the hull transducer installations)

INSTALLATION

TRANSOM INSTALLATION

Do not begin this transducer installation until you read the Installation Preparation in the Operation Guide. This chapter contains information critical to the correct installation of your transducer.

Due to the wide variety of boat hulls, only general instructions are presented in the installation guide. Each boat hull represents a unique set of requirements that should be evaluated prior to installation.

TRANSOM INSTALLATION

Step One - Determine Where to Mount the Transducer

Begin the transducer installation by determining where on the transom to install the transducer. Consider the following to find the best location:

- It is very important to locate the transducer in an area which is relatively free of turbulent water. As a boat moves through the water, turbulence is generated by the weight of the boat, and the thrust of the propeller(s). This turbulent water is normally confined to areas immediately aft of ribs, strakes or rows of rivets on the bottom of the boat, and in the immediate area of the propeller(s) (Figure 1). On outboard or inboard/outboard boats it is best to stay at least 15" (40cm) to the side of the propeller(s).
- If possible, viewing the transom of the boat while the boat is moving will provide the best means of locating turbulence free water. If maximum high-speed operation is a high priority, this is the recommended method. If this is not possible, select a location on the transom where the hull forward of this location is smooth, flat, and free of protrusions or ribs.
- The transducer when mounted should point straight down. The design of the transducer will accommodate a wide range of deadrises and remain ported straight down (Figure 2).
- On boats with stepped hulls, it may be possible to mount the transducer on the step. Never mount the transducer on the transom behind a step, as this area of the transom will not be in contact with the water at high speed (Figure 3).

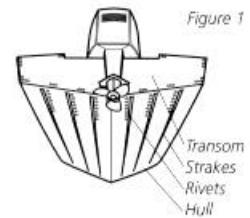

Transom Mounting Location

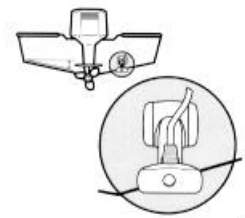

Figure 2

Stepped Hull

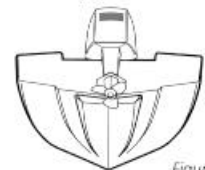

Figure 3

INSTALLATION

TRANSOM INSTALLATION

- If the propeller(s) is (are) forward of the transom, it may be impossible to find an area clear from turbulence, and a different mounting technique or transducer type should be considered.

Step Two - Drill the Mounting Holes

1. Remove the mounting template from the front of the Operations Manual.
2. Hold the template on the transom of the boat in the location where the transducer will be installed (Figure 4). Align the template vertically, ensuring the lower edge of the transom meets with the bottom corner of the template.
3. Using a pencil or punch, mark the two mounting holes shown on the template onto the transom. Do not mark or drill any other holes at this time.
4. Using a 5/32" (4mm) bit drill the two holes to a depth of approximately 1" (3cm). On fiberglass hulls, it is best to start with a smaller bit and use progressively larger drill bits to reduce the chance of chipping or flaking the outer coating.

Template alignment

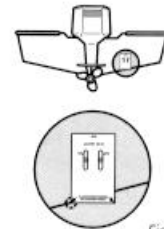

Figure 4

Transducer Assembly

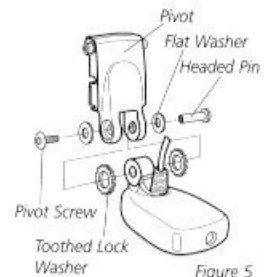

Figure 5

Step Three - Assemble the Transducer

1. Attach the Pivot to the transducer body as shown in Figure 5, using the #8 – 3/8" (9mm) long allen headed pivot screw, the headed pin, the two flat washers, and the two toothed lock washers.

Note: The toothed lock washers must be positioned between the transducer and the pivot ears. The flat washers must be positioned to the outside at the pivot ears.

2. Using the Allen wrenches provided, loosely tighten the pivot screw (Figure 6). Do not completely tighten the assembly at this time, so the pivot angle can be adjusted later.
3. Insert the pivot/transducer assembly into the mounting bracket as shown in Figure 7. Do not snap the assembly closed.



Figure 6

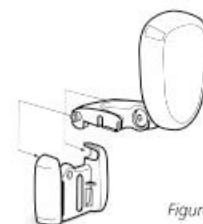

Figure 7

INSTALLATION

TRANSOM INSTALLATION

Step Four - Mount the Transducer to the Transom

1. Apply silicone sealant to the mounting holes drilled into the transom.
2. Align the transducer assembly with the drilled holes in the transom (Figure 8).
3. Use either a flat head screwdriver, a 5/16" (8mm) hex driver, or a 5/16" (8mm) socket to mount the assembly. Using the two #10 – 1" (25mm) long slotted hex head screws, mount the transducer assembly to the transom as shown. Do not fully tighten the mounting screws in order to vertically adjust the transducer. Snap the pivot down into place.

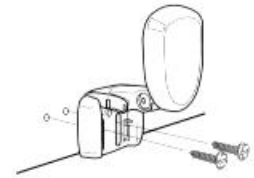

Figure 8

Step Five - Adjust the Running Position of the Transducer

The bracket allows height and tilt adjustment, the pivot screws allow angular adjustment. Initially, adjust the transducer as described in the following paragraphs. Further adjustment may be necessary to refine the installation after high speed testing.

1. First adjust the pivot angle of the transducer body so its length is parallel with the length of hull of the boat. Then pivot the transducer down so the rear is about 1/4 inch (6mm) lower than the front (Figure 9).
2. Fully tighten the two pivot screws using the Allen wrenches. It may be necessary to retighten the pivot screws after the initial use as the plastics may still be seating to the lock washers.
3. Adjust the height of the assembly so the face of the transducer is 3/16" (4.5mm) beneath the lower edge of the transom (Figure 10). Mark the position of the mounting bracket on the transom with a pencil.
4. Force the pivot to the up position to gain access to the mounting screws. Assure the transducer location has not changed, then fully tighten the two mounting screws (Figure 11). Snap the pivot back down.

Running Position Adjustment



Figure 9

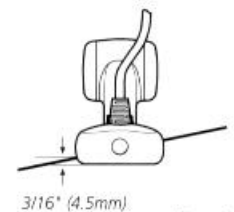

Figure 10

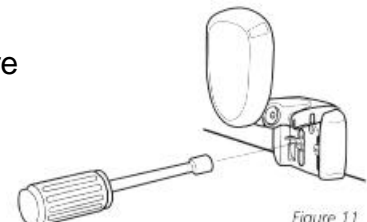

Figure 11

Confirm the pivot angle has not changed.

Note: A third screw location is provided for the

mounting bracket. Drill this hole and install the screw after final testing and adjustments have been completed.

INSTALLATION

TRANSOM INSTALLATION

Step Six - Route the Cable

There are several ways to route the transducer cable to the area where the control head will be installed. The most common procedure routes the cable through the transom into the boat.

Inside the boat there is often a channel or conduit used for other wiring that the cable can be routed along. Do not cut or shorten the transducer cable and try not to damage the cable insulation. Route the cable as far as practical from the VHF radio antenna cables or tachometer cable to reduce the possibility of interference.

If the cable is too short, extension cables are available to extend the transducer cable up to a total of 50' (15 m). Call Humminbird Customer Support for more information.

Follow these steps to route the cable through the transom:

1. Drill a 5/8" (16mm) hole above the water line. Route the cable through the hole.
2. Fill the hole with silicone sealant.
3. Place the escutcheon plate over the hole and attach with the two #8 x 5/8" (16mm) screws.
4. Secure the cable by attaching the cable clamp to the transom using a #8 x 5/8" (16mm) screw.

Note: The transducer will pivot up to 90 degrees in the bracket. Allow enough slack in the cable for this movement. It is best to route the cable to the side of the transducer so the cable will not be damaged by the transducer during movement.

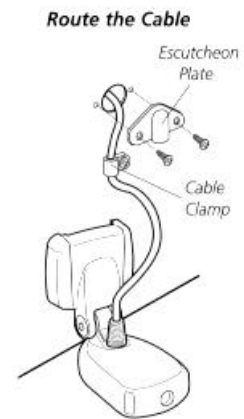

Figure 12

INSTALLATION

INSIDE THE HULL INSTALLATION

INSIDE THE HULL INSTALLATION

Inside the hull installation requires the mount system and control head be installed and operational. See Installing the Control Head for instruction on installing the unit.

Inside the hull mounting generally produces good results in single thickness fiberglass-hulled boats. Humminbird cannot guarantee depth performance when transmitting and receiving through the hull of the boat since some signal loss occurs. The amount of loss depends on hull construction and thickness, and the installation.

This installation requires slow-cure two-part epoxy. Do not use silicone or any other soft adhesive to install the transducer, as this material reduces the sensitivity of the unit. Five minute epoxy has a tendency to cure before all the air bubbles can be purged.

Step One - Determine the Mounting Location

Begin the transducer installation by determining where inside the hull to install the transducer. Consider the following to find the best location:

- Observe the outside of the boat hull to find the areas that are mostly free from turbulent water. Avoid ribs, strakes, and other protrusions as these create turbulence (Figure 14).
- As a general rule, the faster the boat can travel the further aft and closer to the centerline of the hull the transducer has to be located to remain in contact with the water at high speeds.

Step Two - Test the Mounting Location

There is no opportunity for adjustment after the transducer glued in place. Therefore, it is best to perform a trial installation on inside the hull transducers first, and run the boat at high speeds to determine the best mounting area.

1. At the identified mounting location, lay the transducer body face down with the pointed end towards the bow.
2. Fill the hull with enough water to submerge the transducer body. Use a sand filled bag or other heavy object to hold the transducer in position.

Transducer Mounted
Inside the Hull



Figure 13

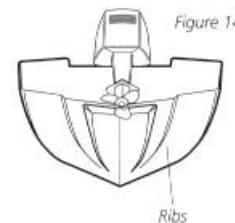

Figure 14

Preferred Mounting Area



Figure 15

The transducer cannot transmit through air. The water purges any air from between the transducer and the hull and fills any voids in the coarse fiberglass surface.

INSTALLATION

INSIDE THE HULL INSTALLATION

3. Power up the Control Head.
4. Run the boat at various speeds and water depths while observing the screen on the Control Head. If the unit functions well at low speeds but begins to skip or miss the bottom at higher speeds, the transducer needs to be moved. If depth performance is required, test the fishfinder in water at the desired depth. Test different locations in the hull until the optimum performance is achieved.

Step Three - Permanently Mount the Transducer

1. Once the mounting location is determined, mark the position of the transducer.
2. Remove the water from inside the hull and thoroughly dry the mounting surface. If the surface is excessively rough, it may be necessary to sand the area to provide a smooth mounting surface.

Ensure the mounting area is clear and dry.

3. Mix an ample quantity of two-part slow-cure epoxy slowly and thoroughly. Avoid trapping air bubbles.
4. Coat the face of the transducer and the inside of the hull (Figure 16).
5. Press the transducer into place with a slight twisting motion to purge any trapped air from underneath, keeping the pointed end of the transducer body pointed forward (Figure 17).

Note: Proper operation requires the pointed end of the transducer body to face towards the bow.

6. Weight the transducer so it does not move while the epoxy is curing.

When the epoxy cures, no water is necessary inside the hull. Neither water, spilled gasoline, or oil will affect the performance of the transducer.

Figure 16

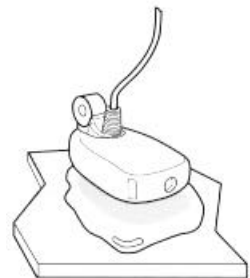
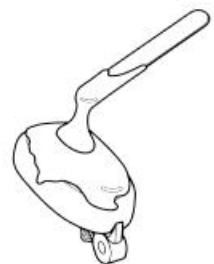

Figure 17

INSTALLATION

CONTROL HEAD INSTALLATION

CONTROL HEAD INSTALLATION

Step One - Determine Where to Mount

Begin the installation by determining where to mount the control head. Consider the following to determine best location:

- The cables for power, transducer and temp/speed accessories (if applicable) should be installed first and must reach the mounting location. Extension cables are available.
- There are two ways to route the cables to the unit: through a hole in the mounting surface underneath the mounting bracket or from a hole outside the mounting bracket. Routing the cables down under the mount provides maximum weather protection; however this is not always feasible if the area under the fishfinder is inaccessible. In this case, route the cables through a hole at another location and cover with the supplied hole cover.
- The mounting surface should be adequately supported to protect the fishfinder from excessive wave shock and vibration, and provide visibility while in operation.
- The mounting area should allow sufficient room for the unit to pivot and swivel freely, and for easy removal and installation (Figures 18-19).

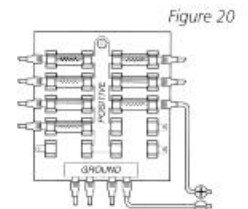
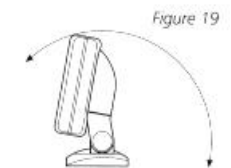
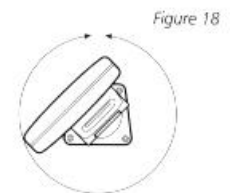

Step Two - Connect the Power Cable to the Boat

A 6' (2m) long power cable is included to supply power to the fishfinder. You may shorten or lengthen the cable using 18 gauge multi-stranded copper wire.

CAUTION: Some boats have 24 or 36 volt electric systems. Be sure your unit is connected to a 12 VDC power supply.

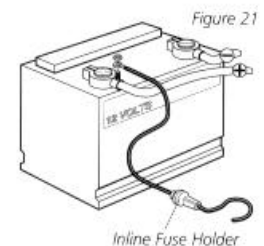

The Power can be connected to the boat's electrical system at two places: a fuse panel, usually located near the console, or directly to the battery.

If a fuse terminal is available, use crimp-on type electrical connectors (not included) that match the terminal on the fuse panel. Attach the black wire to ground, and the red wire to 12 VDC power (Figure 20). Be sure to use a one amp

fuse in the connection. If you must wire the control head directly to a battery, be sure to install an inline fuse holder

INSTALLATION

CONTROL HEAD INSTALLATION

and one amp fuse (not included) for the protection of the unit (Figure 21). Humminbird is not responsible for over voltage or over current failures.

In order to minimize the potential for interference with other marine electronics a separate power source (such as a second battery) may be necessary.

Step Three - Drill the Mounting Holes

1. Set the mounting bracket in place on the mounting surface. Mark the four mounting screw locations with a pencil or punch.
2. Set the mounting bracket aside, and drill the four mounting screw holes using a 9/64" (3.6mm) bit.

Step Four - Run the Cables

1. If the cables must pass through a hole underneath the mounting surface, mark and drill a 1" (25mm) hole centered between the four mounting holes (Figure 22).

Note: if the cables must pass through the mounting surface at a different location, drill the 1" (25mm) hole at that location and pass the cables through from underneath. Also, you must break out the tabs on the rear of the mounting base using needle nose pliers (Figures 24-25).

2. Insert all cables through the 1" (25mm) hole from beneath the mounting surface.
3. Pass the cables through the grommet (if the cable hole is underneath the mounting bracket) then press the grommet in place around the cables and into the 1" (25mm) hole.
4. Pass the cables through the mounting base, out the top of the mounting bracket.
5. Place the mounting bracket on the mounting surface aligned with the drilled holes. Insert the four flathead wood screws into the mounting holes and tighten fully (Figure 23).

Figure 22
1" (25mm) Hole Location

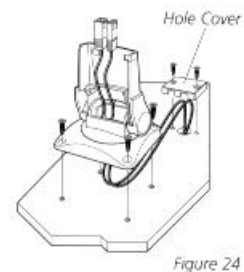
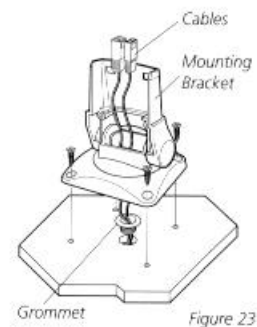
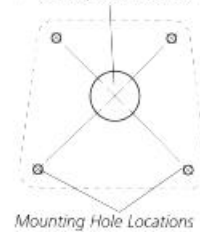

Optional: If the cables pass outside the mounting bracket, install the hole cover over the hole and fasten in place using the two #8 x 7/8" (22mm) wood screws (Figure 24).

INSTALLATION

CONTROL HEAD INSTALLATION

Step Five - Assembling the Connector Holder

1. Insert the cable connectors into the connector holder. The cable connectors are labeled, and there are corresponding labels on the connector holder (Figure 26). The slots for the connectors are keyed to prevent reverse installation, so do not force the connector into the holder.
2. Carefully pull the excess cable from beneath the - mounting surface so the connector holder aligns with the mounting holes on the front of the mounting bracket (Figure 27).
3. Snap the support plate to the rear of the connector holder (Figure 28).
4. Insert the connector holder into place and use the two #6-32 x $\frac{3}{4}$ " (9mm) screws to fasten it to the mounting bracket (Figure 28).
5. Install the control head by sliding it onto the mounting bracket until it is fully seated. To remove the unit simply depress the latch on the rear of the unit and lift (Figure 29).

Your Humminbird is now ready for operation.

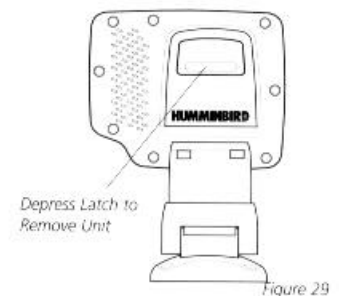
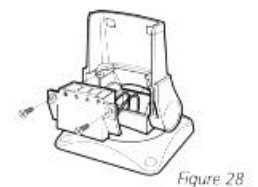
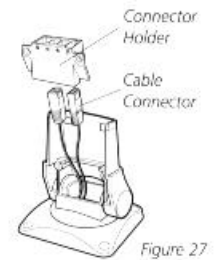
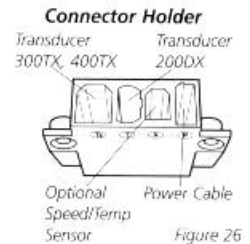

INSTALLATION

TEST THE INSTALLATION

TEST THE INSTALLATION

Testing should be performed with the boat in the water, however you can initially confirm basic operation with the boat trailered.

Press POWER once to turn the unit on. There will be an audible chirp when any button is pressed to confirm the button press. If the unit does not power-up, ensure the unit is fully seated on the mount and that power is available.

The first screen provides four options: Start-up, Options, Simulator, and Diagnostic. A message at the bottom of the screen indicates the transducer connection. If no transducer is detected (or one is not connected), the message will indicate this and the unit will go into simulator after the initial screen times out.

Note: the transducer must be submerged in water for reliable transducer detection.

If a transducer is detected, the unit will enter “Start Up” or normal operation unless you choose another option. If you do not press any button before the timer reaches “0”, the normal operation screen is displayed. If the boat is in water, sonar data appears.

If the bottom is visible on screen with a digital depth readout, the unit is working properly. Ensure the boat is in water greater than 2’ but less than the depth capability of the unit and the transducer is fully submerged. Remember the sonar signal cannot pass through air.

If the unit is working properly gradually increase the boat speed to test high-speed performance. If the unit-functions well at low speeds but begins to skip or miss the bottom at higher speeds, the transducer requires adjustment. Refer to the appropriate transducer installation section for more detail.

Note: it is often necessary to make several incremental transducer adjustments before optimum high-speed performance is achieved.

Important: For Transom Mount transducer installations, install the third mounting screw after the final transducer adjustments.



Humminbird • 3 Humminbird Lane • Eufaula, Alabama 36027

Card Reader Installation

The card reader has two mounting options. You may mount it on a vertical or horizontal flat surface, or you may mount it in-dash in a dry area.

The card reader is not waterproof. Take this into consideration and follow these steps for surface and in-dash mounting.

Surface Mount

1. Locate a dry, flat surface within cable distance of the control head (cuddy, electronics compartment, etc.). Make sure the location permits easy access for inserting and removing cards.

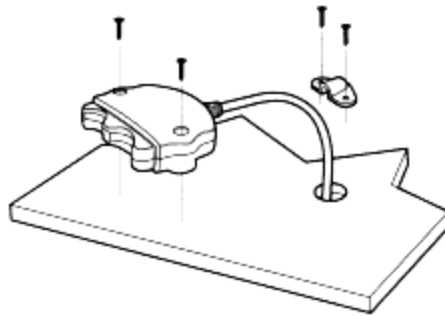

2. Place card reader in mounting position, use 1 1/4" screws to mark holes for mounting then remove card reader and drill holes using a 9/64" drill bit.
3. Align card reader with drill holes, secure to surface with #8 x 1/4" flat head philips screws.
4. Drill a 5/8" hole approximately two inches behind card reader for cable routing, then feed cable through hole.
5. Place escutcheon plate over hole and mark for drilling. Drill 9/64" holes.
6. Feed card reader cable through hole.
7. Align escutcheon plate with mounting holes, use #8 x 5/8 pan head philips screws to secure cover.

In-dash Mount

1. Locate a dry, flat surface within cable distance of the control head (cuddy, electronics compartment, etc.).
2. Tape template enclosed inside front cover of manual to mounting location.

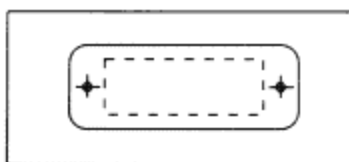

3. Use a 9/64" drill bit to drill holes at each end of the bezel template. At a location inside the dotted line, drill a hole large enough to insert blade of reciprocating saw. Carefully begin cutting up toward dotted line, then follow dotted line around template. Remove template when finished.
4. Insert card reader housing through back side of bezel until bezel snaps onto card reader housing. Ensure larger tab of bezel is on top and the serial number on the card reader is facing downward.

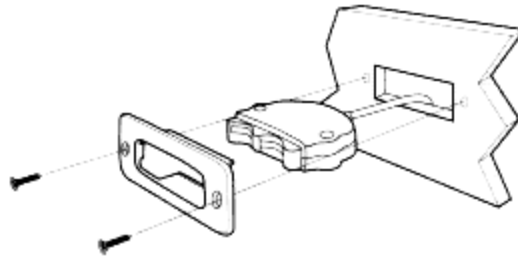

5. Mount card reader into hole from the front. Ensure larger tab of bezel is on top and serial number on the card reader is facing downward. Secure bezel/card reader to dash using two #8 x 5/8 screws. Feed cable up through cable hole to the swivel mount location.

Working with C-Cards

Cartography stored on a C-Card provides detailed coverage for the area you are navigating. Buoys, lighthouses, wrecks, beacons, etc., display in the map view. The card reader equipped with the NS25 holds two C-Cards simultaneously and automatically detects which one to use while you are navigating.

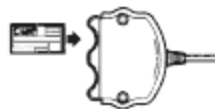

The NS25 cannot recognize a C-Card if it is not properly placed in the card reader. To place a C-Card in your card reader, gently insert it face up with the gold plating facing downward. The C-Card and the slots on the card reader are keyed for correct insertion. Press the C-Card all the way in, then press it downward past the stops on each side of the slot. This will prevent the C-Card from coming out while in use and is needed to complete the electrical connection of the C-Card to the card reader.

Note: When using only one C-Card, it can be inserted in either slot.

NS25 Control Head Installation

Before starting, consider where to mount the control head. You can preassemble the unit to the mounting bracket and try different locations on the boat. The cables for power, GPS receiver, card reader and transducer should be installed first and must reach the mounting location. Extension cables are available.

If your boat has an electrical system, there is probably a fuse panel in the console area, which can be used to attach the NS25 power cable. If a fuse terminal is available, use crimp-on type electrical connectors (not included) which match the terminal on the fuse panel. Attach the black wire to ground, and the red wire to 12 VDC power. Be sure to use a 1.5-amp fuse in the connection. A 6 foot long power cable is included. You may shorten or lengthen the cable using 18 gauge multi-strand copper wire.

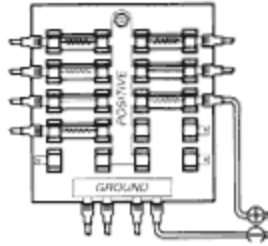

CAUTION: Some boats have 24 or 36-volt electric systems. Be sure your NS25 is connected to a 12 VDC power supply. If you must wire the NS25 directly to a battery, be sure to use the in-line fuse holder and 1.5-amp fuse provided for the protection of the unit. Hummingbird is not responsible for over-voltage or over-current failures.

To minimize the potential for interference with other marine electronics, particularly VHF radios, route the transducer cable and the antenna cable as far apart as possible. A separate power source may be necessary to eliminate interference.

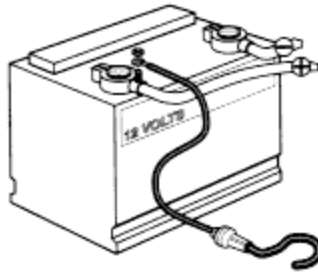

Before installation, gather the parts needed: control head, mounting bracket, connector holder, power cable, and mounting hardware.

There are two different ways to route the cables to the unit: through a hold in the mounting surface underneath the mounting bracket, or from a hold outside the mounting bracket. It is preferable to route the cables from underneath the bracket for maximum weather protection; however, access to this area may not be possible.

If the cables must pass through the mounting surface at a point not covered by the mounting bracket, a hole cover is supplied to provide maximum protection for this opening.

Consider also that the mounting surface should be adequately supported to protect the control head from excessive wave shock and vibration, and provide visibility while in operation.

The mounting area should allow sufficient room for the unit to pivot and swivel freely, easy removal and installation.

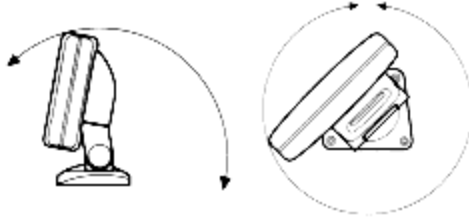

Drilling the Mounting Holes

After you have determined the best mounting location for your control head, proceed with the following instructions:

- 1. Depress the latch on the rear of the unit and separate the unit from the mounting bracket.*

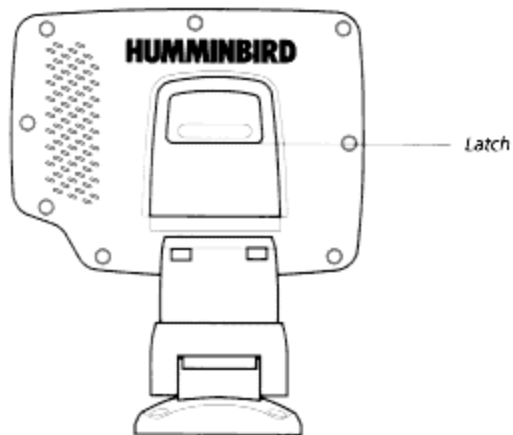

- 2. Set the mounting bracket on the mounting surface.*
- 3. Mark the four mounting screw locations with a pencil or punch.*

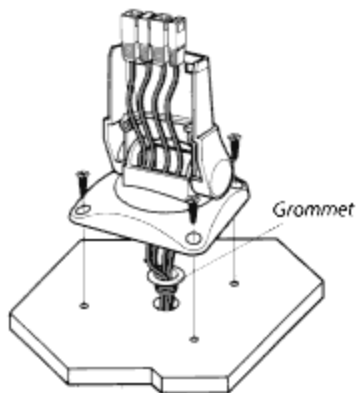

- 4. Set the mounting bracket aside and drill the four holes using a 9/64" bit.*
- 5. Mark and drill a 1" hole centered between the four mounting screw holes.*

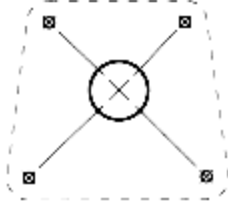

NOTE: If the cables must pass through the mounting surface at a different location, drill the 1" hole at that location and pass the cables through from underneath. Also, you must break out the wire slots on the rear of the mounting base using needle-nosed pliers.

6. Insert all cables through the 1" hole and grommet from beneath the mounting surface.
7. Pass cables first through the grommet (if the cables hold is underneath the mounting bracket), then through the mounting base and top of mounting bracket.
8. Press the grommet in place around the cables and into the 1" hole.
9. Place the mounting bracket on the mounting surface aligned with the drilled holes. Insert the four flat-head wood screws into the mounting holes and tighten fully.

Optional: If the cables pass outside the mounting bracket, install the hold cover (supplied) over the hold and fasten in place using the two #8 x 7/8" wood screws provided.

Assembling the Connector Holder

Follow these steps to assemble the connector holder.

1. Insert the cable connectors into the connector holder. The slots for the connectors are keyed to prevent reverse installation, so be careful not to force the connector into the holder.

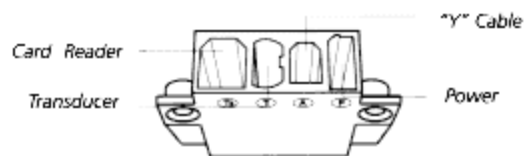

2. Carefully pull the excess cable from beneath the mounting surface so the connector holder aligns with the mounting holes on the front of the mounting bracket.
3. Snap the support plate to the rear of the connector holder as shown.

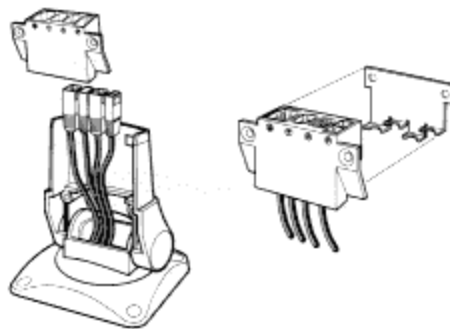

4. Insert the connector holder into place and use the two #6-32 x3/4" screws to fasten it to the mounting bracket.

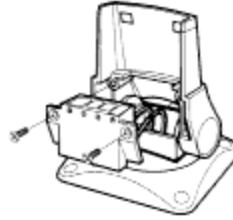

5. Install the control head by sliding it onto the mounting bracket until it is fully seated. Then unit should snap into place. (To remove the unit, simply depress the latch on the ear of the unit and lift.)

Your NS25 unit is now ready for operation.



Testing The Installation

GPS Testing

Check System Status screen to confirm the unit is picking up satellite signals (shown in Satellite Status box). Once three satellite icons turn black, and the "Receiver Status" displays "Position Fix," the unit will automatically select the North-Up view to display your location.

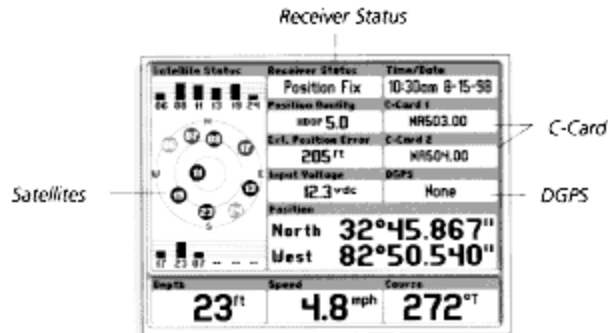

It may take several minutes to acquire a position. The receiver status field changes from "Acquiring" to "Position Fix" once a position is acquired.

C-Card

Check System Status “C-Card” field to confirm NS25 is reading C-Card information. If the fields display “NONE,” check card reader cable connection and make sure cards are securely seated. When cards are properly inserted the C-Card field displays the card number, such as NA503.4.

Sonar

If the bottom is visible on-screen with digital depth readout, the unit is working properly. Remember, the sonar signal cannot pass through air. If the unit is working properly, gradually increase the boat speed to test high-speed performance. If the unit functions well at low-speeds but begins to skip at higher speeds, the transducer installation requires adjustment.

Start-Up



The NS25 is completely automatic and easy to use. Simply press the POWER button and select Start-Up. This mode determines your position and displays it on a map, tracks the bottom from 2 feet to 1000 feet displaying structure and suspended fish, and works at speeds from 0 to over 70 mph. Start-Up is the mode of operation for actual use of the NS25.

Cartography Notice



C-Map Cartridges Installed:
Card 1: 357 Key Biscayne to Sebastian Inlet 7/2/95
Card 2: None

When starting up the NS25, a cartography notice displays to indicate which C-Map cartridges are in the card reader.

Feature Memory

Any changes you make to the user settings while in Simulator or Start-Up (normal operation) are retained in the unit's memory. This allows you to use the Simulator at home to experiment with the various set-up options, and retain your selected settings for normal operation. However, changes made while in Demonstration mode will not save.

Simulator Operation

The NS25 contains a Simulator mode that allows you to use the unit as if you are on the water and learn how to operate many of the features. The Simulator location is in a detailed area of the built-in map. It can be changed to an area you are familiar with, however, the most detailed area is the default location. In Simulator mode, the unit saves all waypoints, routes, settings, and changes.



Selecting the simulator option on the Start-Up screen after your power-up the unit enables the simulator. When this screen is shown, simply press the DOWN ARROW to highlight “Simulator.” When the screen times-out, the unit will be in simulator mode. To exit simulator mode, turn the unit off.

Demonstration Operation



The NS25 has a demonstration function that works like the simulator. However, this operation is only accessible if no GPS Receiver is detected. Settings and waypoints are not saved to unit memory while in demonstration mode. To exit demonstration mode, turn the unit off.

Getting Started

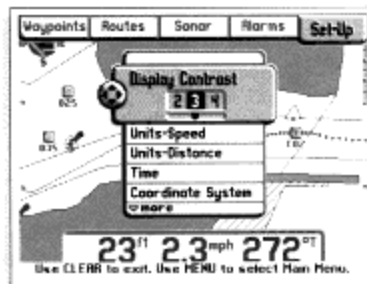

As you begin using the NS25, there are some features in the set-up menu that you may want to customize to set up the unit’s full functionality. For example, you may want to select and adjust Units/Speed, Units/Distance, Time Format, Coordinates, or North Reference. See the Set-Up section under “Using the Menu System” for more information.

Button Functions

The NS25 has 10 buttons to control all unit functions. Buttons are used for navigation options and entering data. See the following illustration and descriptive table listing buttons and functionality.

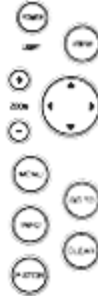

Power/Light: Turns on the unit initially. Pressing and holding the Power button for three seconds turns unit off. Pressing it briefly while the unit is operating displays the Adjust Backlight menu.

View: Selects the six different views: North-Up, Course-Up, Combo, Sonar, Numeric, and System Status.

Cursor: Used to move the cursor (cross-hair line visible in graphics area), pan the map, and select waypoints. Used to make selections when menus are displayed.

Zoom +/-: Controls the range at which the map is drawn on the screen. The “+” button increases the map range. The “-“ button decreases the map range.

Menu: Displays the Main Menu Bar list and toggles through each of the five menu options.

Go To: Initiates navigation to a destination.

Info: Displays detailed information for highlighted waypoints. Controls information display settings for graphical and numeric information.

P-Star: Instantly stores the location of your present position. If the cursor is on-screen, the cursor position is stored.

Clear: Exits any current operation, clears screen of bird-notes, and mutes an active alarm. When no action has been initiated a menu provides options to clear course history, current route, and temporary waypoints.

Views

Six views in the NS25 display your position, maps, numeric information boxes, and sonar information.

Press the VIEW button to toggle between each of the views in the sequence: North-Up, Course-Up, Combo, Sonar, Numeric, and System Status. This toggle function is a continuous loop, so if you miss a view, keep pressing the VIEW button to return to the view you would like to display.

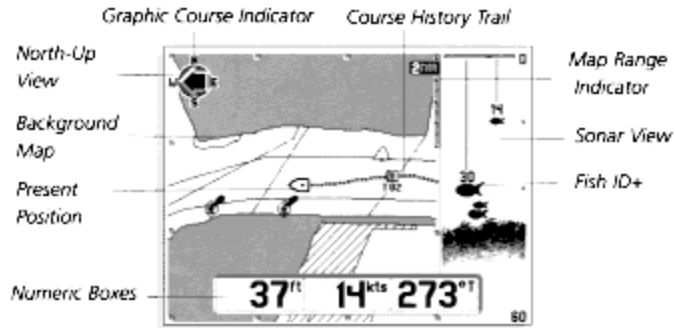

On views displaying a map, your present position is indicated by a square if you are stationary, or a boat icon if you are moving. The graphic course indicator always shows your course relative to north. A course history trail tracks where you have traveled.

A map range indicator displays the current map range selected by the Zoom +/- buttons.

NOTE: C-Cards contain different map ranges depending on the card and your area of operation. More detailed map ranges will be available in some areas, and less detail in others.

All views can be customized to display more or less detailed numeric and graphic information (see "User Customization" for detailed information).

North-Up View

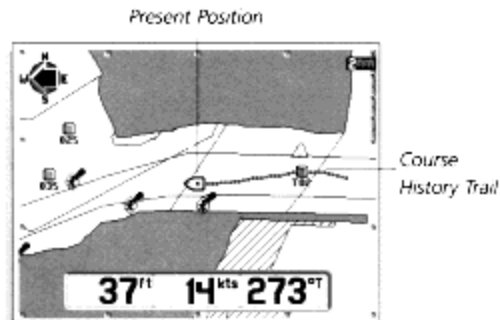

The North-Up view is the initial view once the NS25 has determined its position. Your present position is always in the center of the view, with the map in the background. As your position changes, the map scrolls in the background to keep your present position in the center of the screen and to track the course history trail.

Course-Up View

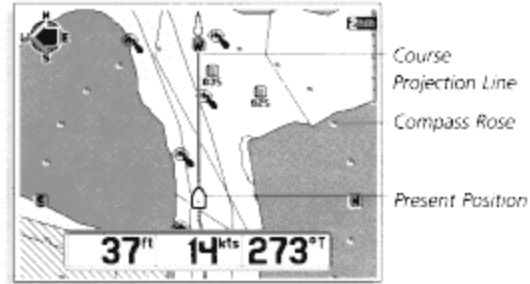

The Course-Up view orients the map with your direction of travel at the top of the screen. Your present position is always centered left to right just below the center of the view. A course projection line connecting from your present position to a compass rose indicator displays your direction of travel. If the course projection deviates more than 10 degrees, the map redraws your new course at the top of the screen.

If you are not moving, the NS25 cannot determine a course and will show the map oriented to the north.

Combo View

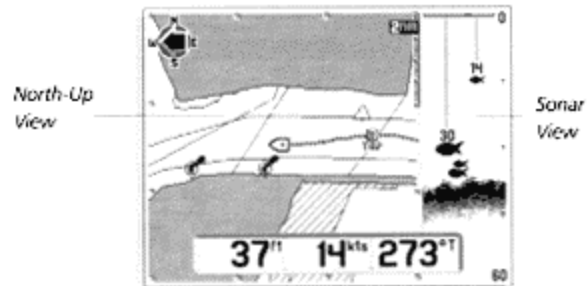

The Combo view is a combination of the North-Up and Sonar views. In this view you can simultaneously view targets above and below water surface to gauge your position on the map relative to underwater objects. The North-Up view displays in $\frac{3}{4}$ of the screen, the Sonar view displays in the remainder of the screen.

Sonar View

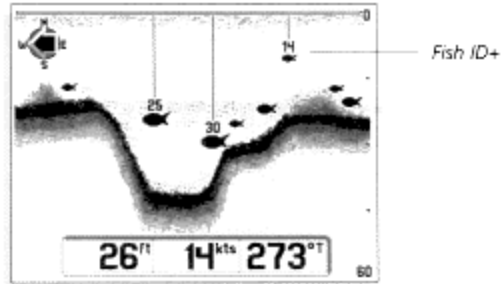

The Sonar view graphically depicts all sonar targets below the water surface, such as fish and structure. New sonar information appears on the right side of the graphic area and moves to the left as new information is gathered. Fish ID+ represents sonar targets detected as fish symbols with a depth.

Numeric View

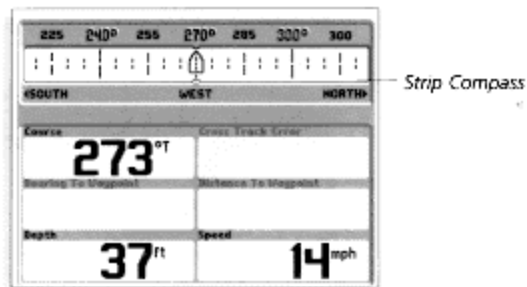

*Numeric View When Not
Traveling a Route*

The Numeric view provides digital information about your present position, and while traveling a route provides precise information for navigating to waypoints.

In the Numeric View, a strip compass appears at the top of the display to graphically depict your course. Digital readouts provide depth, speed and course information. Some information boxes may be blank when not traveling a route.

When traveling a route, the name of the route and waypoint display at the top of the screen. All six information boxes display providing detailed navigation information.

A cross track error indicator displays showing your position relative to the track line, and off-course alarm boundaries. The Zoom +/- buttons change the range of the cross track error indicator.

System Status View

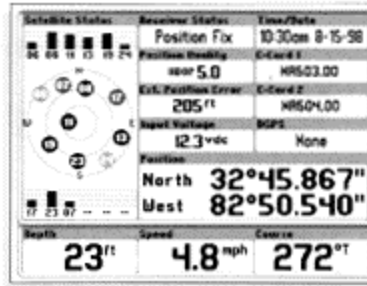

The system Status view provides detailed information about the performance of the NS25. This view will appear after start-up if a position is not acquired. This allows you to monitor the status of the NS25 as it acquires satellites and determines your position.

The Satellite Status info box indicates positions of satellites in the sky. Satellites with poor signal strength are indicated by gray icons: satellites with good signal strength are indicated by black icons. Numbered bar graphs corresponding to each satellite show relative signal strength.

The receiver Status info box indicates “Acquiring” if the unit is in the process of determining a position, or “Position Fix” if the unit has acquired a position. In Simulator or Demonstration mode, Receiver Status displays “Simulation”.

The Position Quality status displays the Horizontal Dilution of Precision (HDOP). Ranging from 0-99, it is calculated through a measurement of the satellite positions that affect your position. The Estimated Position Error displays an estimate of how far you are from the actual coordinate position.

The Voltage Input displays the current voltage of the boat's electrical system.

The time/date field displays the current time and date.

Note: Time can be adjusted in the Set-Up menu option; the date is set by the satellite signal received by the GPS receiver and is not adjustable.

The C-Card Status boxes display the reference number of the cards inserted. If no card is inserted, “NONE” displays in the box. If a problem is detected, the “ERROR” displays in the box.

The DGPS info box displays “None” if an optional DGPS receiver is not connected. If there is one connected, and a signal is receiving, “Receiving” displays in this box.

E it as Temporary

Storing a Position (Waypoint)

Storing a position, or waypoint, is helpful in tracking areas of interest or marking points for navigation. You may store up to 250 permanent waypoints and 50 temporary waypoints. Permanent waypoints are retained in permanent memory; temporary waypoints are not and will be lost when the NS25 is turned off. Several options for creating waypoints are available with the NS25.

Pressing P-Stor instantly stores your present position, with depth of water information. A Store As menu Displays to provide the option to save it as Temporary or Permanent.

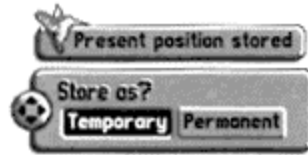

Pressing P-Stor while the Cursor is on-screen stores the position of cursor. The Store As menu provides the option of saving a Temporary or Permanent waypoint.

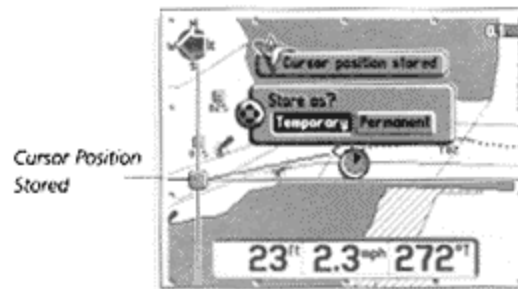

Using the Create Waypoint option in the Main Menu also stores waypoints and saves them to the Permanent waypoint list. Using the menu system you can enter precise coordinates for a waypoint and immediately assign a name and symbol.

Once a waypoint is stored, the waypoint is indicated on-screen by one of several symbols shown below.

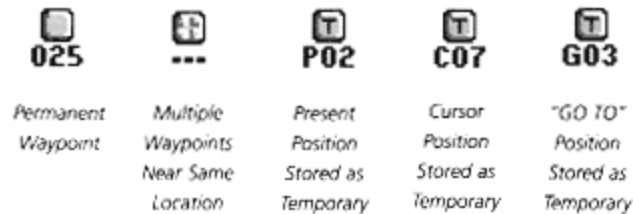

Information stored with a waypoint includes position, distance, bearing, date created, number of times visited. Visits accrue each time a waypoint is visited using GOTO. Depth is also saved when storing your present position.



Interacting with On-Screen Information

Using the Cursor in Map and Sonar Views

The cursor is a cross-hair line visible in the graphics area and has several important functions such as selecting on-screen options, panning the map, and determining a position. The simplest and most frequent use of the cursor is to determine the distance and bearing from your present position to some point of interest.

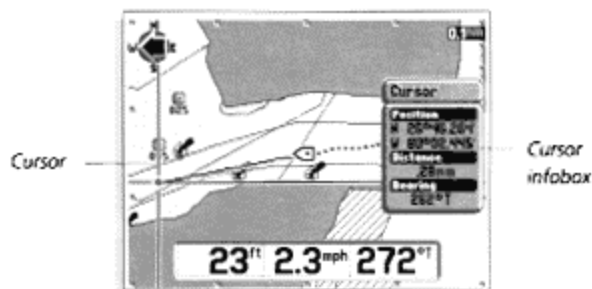

To activate the cursor, simply press the directional arrow in the direction you choose to move. You may press the directional arrow repetitively to slowly move the cursor faster and over a greater distance.

When the cursor is active, the cursor infobox contains information on the coordinate position of the cursor, and the distance and bearing from your present position to the cursor position. This provides a very quick and accurate way to navigate to the cursor position and is helpful in determining your distance from a shoreline, or any point of interest.

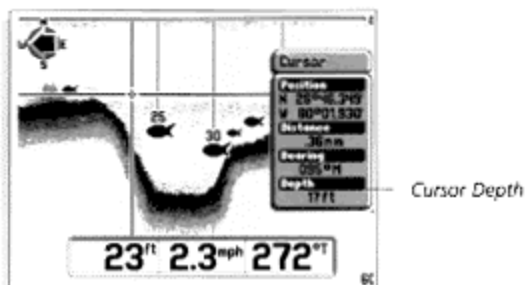

While in the sonar view, the cursor “freezes” the sonar view and displays the Position, Distance, Bearing, and Depth in the Cursor infobox.

Zoom +/- Around Cursor Location for More Map Detail

The Zoom +/- feature controls the range viewed on the map around the cursor position. Press Zoom = to reduce the range of the map. Press Zoom - to increase the range. When adjusting the Zoom feature, a box displays in the graphics area indicating the size of the new range.

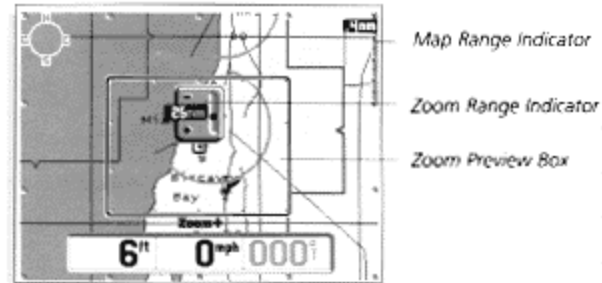

Note: When using C-Cards, the lower zoom levels in the Zoom +/- feature may not display cartography. This depends on the cartridge you are using, and the area of operation.

Using the Cursor to Pan the Map

The cursor may also be used to scroll the map on the display screen. When the cursor reaches the border of the viewing area the map begins scrolling. Press CLEAR to return to the view to show your present position.

Using the Cursor to Get More Detailed Information

The cursor is used with the INFO button to get detailed information on a waypoint. When the cursor is within range, the cursor will “snap” to and highlight the waypoint.

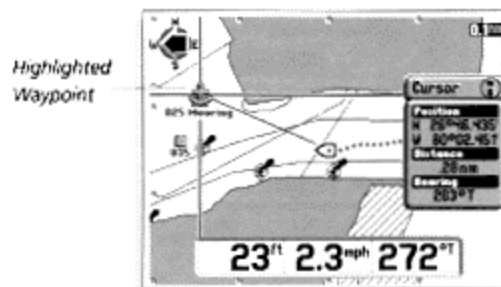

Once the waypoint is highlighted, press INFO to display more detailed waypoint information.



Extremely detailed information is available for objects and areas built into the C-Map cartography. Icons appear on the maps displaying the locations of lights, buoys, and other man made features, as well as natural areas such as tideways, current zones and sea bottom conditions.

Moving the cursor to an object on the C-Map, and pressing INFO displays information about that object.

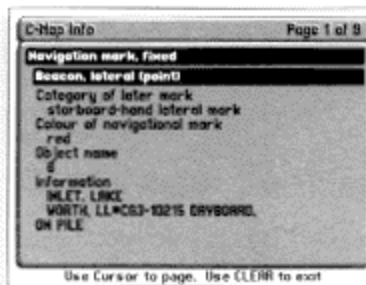

Customizing the Display



The NS25 has customization features for selecting specific information you want to display on-screen, such as place names, depth contours, spot soundings, numeric infoboxes, etc. In any of the views, you may press the INFO button to set the information Priority Level, Customize Numeric Information, and Assign Information Priority Levels. Customization features and their functionality are described below. All views except System Status can be customized.

Adjust Information Priority Level

Information Priority Level menu determines objects drawn on-screen such as place names, waypoints, depth contours and infoboxes. Making adjustments can quickly add or eliminate objects on-screen to reduce clutter. Highlighting fewer numbers in the menu displays less information, highlighting more numbers displays more information. Refer to figures 1 & 2 for examples.

Information Priority Levels can be completely customized to your preferences via the Assign Information Priority Levels menu. This menu accesses the list of objects to which your personal priorities can be assigned (1 is highest priority, 7 is lowest priority).

The information Priority Level menu setting draws the objects on-screen based on these priorities you have set. For example, highlighting the numbers 1, 2, 3, and 4 in the Information Priority Level menu draws objects with a priority of 1, 2, 3, and 4. Highlighting the number 1, only draws objects with a priority of 1.

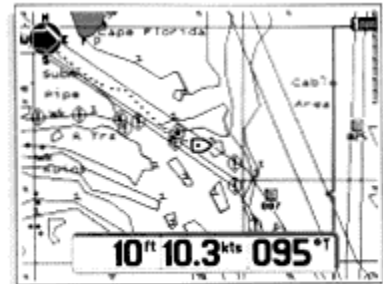

Figure 1. Information Priority Level set to a larger number.

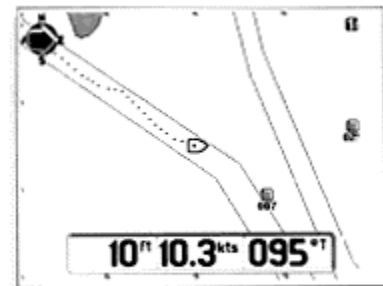

Figure 2. Information Priority Level set to a smaller number.

To Adjust Information Level:

1. In any of the six views, press INFO. The Information Options screen displays.



2. Information Priority Level is the initial menu option in the screen. Select numbers ranging from 1-7 to set the desired information level. Select "1-7" to display all available information. Select "1" to display only the highest priority information.
3. Press CLEAR to save settings and exit the menu.

Note: The screen will update with the new settings.

Customize Numeric Information

This option selects numeric information displayed in each of the infoboxes. These infoboxes appear at the bottom of the screen to provide you navigation and position information. You may customize each view individually to display any or none of the following numeric information.

The following numeric information is always displayed and appears as black text on white background.



Depth – Numeric depth of water directly beneath the boat

Speed Over Ground – Speed of boat, derived from GPS

Course Over Ground – Direction you are traveling measured in degrees from north

Coordinate Position – Present position in units selected in the Set-Up menu

Time/Date – Current time and date derived from GPS

The following numeric information is only displayed when traveling a route and appears as white text on black background.



Distance To Go (DTG) – Distance between present position and the destination waypoint.



Cross Track Error (XTE) – Distance between your present position and intended route of travel.



Course Made Good (CMG) – Bearing from starting waypoint to present position.



Speed Of Advance (SOA) – Speed along intended route.



Bearing (BRG) – Direction to a waypoint expressed in degrees relative to north.



Time To Go (TTG) – Time remaining until waypoint is reached.

Estimated Time of Arrival (ETTA) – Approximate time of day you will arrive at a destination.

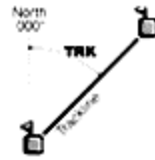

Track (TRK) – Angle of line connecting starting and ending waypoints. Measured from north (000 degrees).

- When displayed in infoboxes, the read-out has an abbreviation next to it indicating which waypoint it references.

To customize Numeric Information:

1. Press the VIEW button to select the view to customize, then press INFO, The Info Options screen displays.
2. Scroll down to Customize Numeric Information, hen select YES.

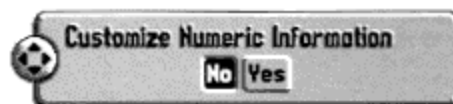

- The Infobox Set For menu displays, use the cursor to scroll through options to select the information to display in the highlighted information box.

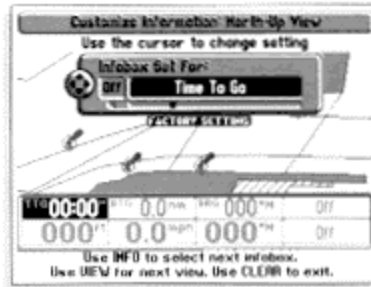

- Press INFO to select each information box at the bottom of the screen.

Assign Information Priority Levels

This option sets the priority level for each object to display on-screen. Information priority levels are assigned to objects drawn on-screen according to your preferences. Objects that you may assign priority levels to include internal indicators (such as Course History Trail or Compass Rose) and external cartography (such as Depth Contours or Spot Soundings).

To Assign Information Priority Levels:

- Press INFO, the Info Options screen displays.
- Scroll to Assign Information Priority Levels, then select Yes.

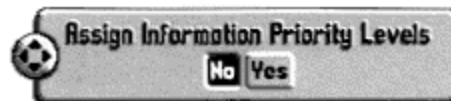

- The Objects screen displays, scroll down through each of the options to assign priority levels 1-7 (1= highest priority, 7 = lowest priority).

Creating and Traveling a Route

Routes link two or more waypoints together to create a path for navigation. You can link individual waypoints together via menus or select them on-screen to create a temporary route. You can select and travel permanent routes previously created by using the Route option on the Main Menu Bar (See “Using the Menu System – Routes” for more information).

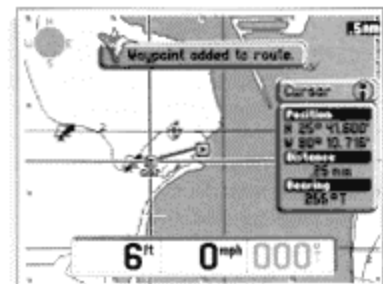

The NS25 stores 10 temporary routes (lost at Power Off), and 20 permanent routes, with up to 50 waypoints in each route.

Note: The NS25 does not route your navigation around land, you must do so manually.

Creating a Route Using CURSOR + GOTO

Using the cursor and GOTO button is the quickest way to create a route. Moving the Cursor to a location and pressing GOTO creates a temporary route between your present position and the cursor position. With this method of navigating, you can select an existing waypoint icon on-screen to navigate to. If there is no existing waypoint icon on-screen, pressing GOTO creates a temporary one. Moving the cursor to another location and pressing GOTO adds successive waypoints to the route.

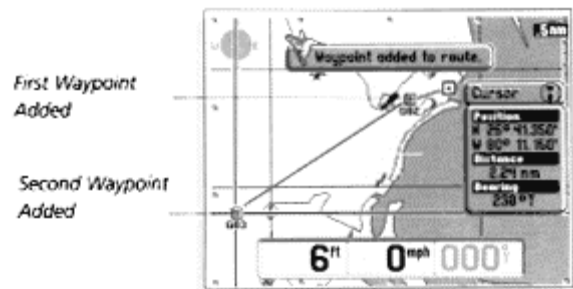

Creating a Route Using the GOTO Button First

Pressing GOTO displays a list of options for creating a route. If you know position coordinates, select Enter Numeric Coordinates. Select Use Cursor to create a route from your present position to a cursor position. To select a waypoint from the waypoint list, choose Select Waypoint From List. Selecting Last P-STOR Position sets the route to the last position stored. Once you have selected waypoints, pressing CLEAR exits and provides navigation information.



Using the Waypoints Menu

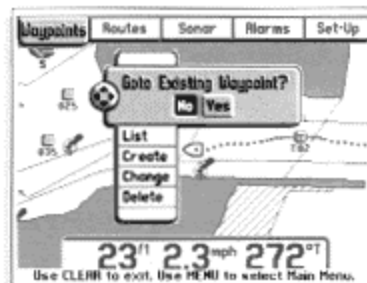

You can create and travel a temporary route through the GOTO options in the Waypoints menu. See "Using the Menu System – Waypoints" for more information.

Using the Routes Menu



You can create and travel permanent routes through the options in the Routes menu. See “Using the Menu System – Routes” section for more information.

On-screen Navigation Information

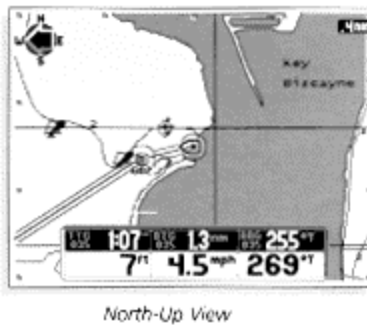

When traveling a route additional infoboxes appear at the bottom of the screen to provide navigation information to the destination waypoint. These boxes are characterized by white text on black.

Navigation infoboxes can be customized for each view to show only the information that you need. See “Customizing the Display” for more information.

When a route is created, all waypoints are connected by a track line. If Off-Course and Arrival Alarms are turned on, the alarm boundaries are drawn on-screen around the track line and designation waypoint.

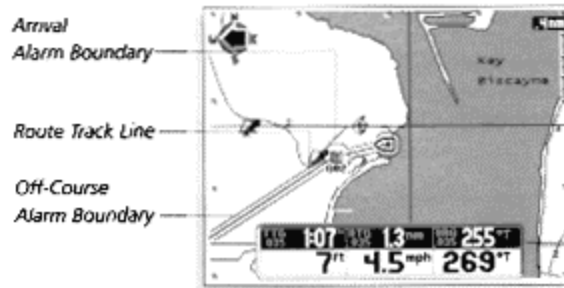

Flag symbols mark each waypoint in the route. “S” designates the starting waypoint, and each following waypoint is marked with a number showing the sequence. The final waypoint is designated with an “E”.



Selecting a View for Navigation

When traveling a route, navigation information appears on the North-Up, Course-Up, Combo, Sonar and Numeric Views. The View you select depends on your situation and personal preference.

The North-Up view displays all navigation information relative to north, and is useful for monitoring your progress along the route and determining course corrections relative to north.



North-Up View

Note: When using map views for navigating, zooming in on the map provides more detailed map course information to help you stay on course.

The Course-Up view orients the map with the direction of travel at the top of the screen. This is useful during navigation as the map and course projection line movement closely relate to corrections made to the boat's course. When used at the more detailed map ranges, the proximity of the course projection line to the track line indicates how accurately the course is being followed.

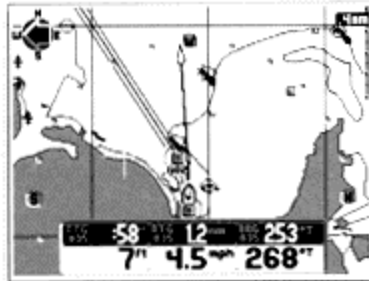

Course-Up View

The Combo view displays the North-Up map and sonar information useful for locating and holding a position over underwater structure.

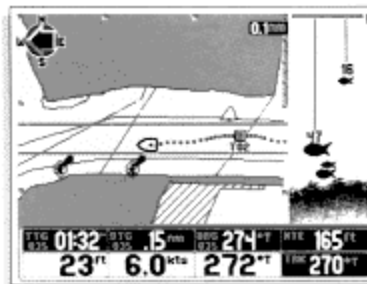

Combo View

The Numeric View displays precise information about your course situation in a large, easy to read format. The Cross Track Error indicator displays present position and course related to the track line.

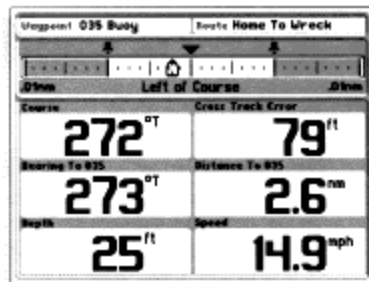

Numeric View

Staying On Course

As you travel the route, staying on the track line is the most efficient way to get to your destination. The Cross Track Error indicator on the numeric or the digital readout provides a precise indication of distance from the track line.

If the Off- Course alarm is on, alarm boundaries are drawn on the map to indicate the alarm settings. If the Cross Track Error exceeds the Off- Course alarm setting, the alarm will sound. The factory setting for Off- Course alarm is .1nm. This can be adjusted to maintain a more precise course (see “Using the Menu System – Alarms” for more information).



Arrival Alarm

If the Arrival alarm is on, an alarm boundary is drawn around the current destination waypoint. When the Distance To Go (DTG) to the Waypoint is less than the alarm setting, the alarm will sound. The factory setting for the Arrival Alarm is .1nm. This can be adjusted manually (see “Using the Menu System – Alarms” – for more information).

Waypoint Sequencing as you move beyond a destination waypoint within the route, the NS25 automatically “sequences” to the next waypoint providing new navigation information.

At times, the NS25 may not be able to determine when to automatically sequence to the next waypoint. When this occurs, a menu displays to permit manual sequencing.

Modifying a Route While Traveling

While traveling a route, you can modify it as you go. You may add waypoints to the end or middle, replace the current waypoint, skip waypoints, or redirect the route entirely.

To skip a waypoint or series of waypoints, use the cursor to highlight the waypoint within the route that you want to go to, then press GOTO. A menu appears to confirm. Select Yes to skip to the new waypoint. The track line redraws your route with updated information.

To make other modifications, use the cursor to highlight a waypoint you wish to change, then press GOTO. A menu displays the options for the highlighted waypoint.

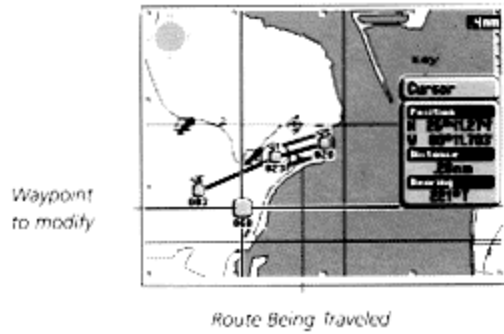

Note: If you have not identified a destination, pressing GOTO gives you options to Enter Numeric Coordinates, Use the Cursor, Select a Waypoint from the Waypoint List, or go to the Last P-Store Position. After selecting the waypoint, the “GO TO” options to modify route menu displays for changing the route.

Choose the option from the menu which changes the route as you need. Refer to the figures below for exact examples of how the route is modified for each selection.

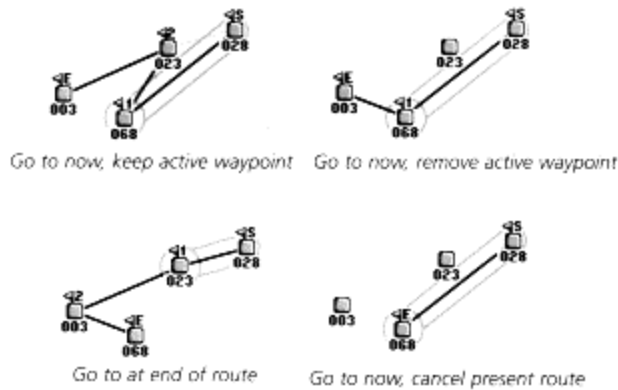

Ending a Route

A birdnote displays to alert you once you have reached the last waypoint in the route.

To end a route, press CLEAR once the final waypoint has been reached. Select YES from the Clear Route menu to end the current route.

Using the Menu System

The NS25 displays five menu options on the Main Menu Bar: Waypoints, Routes, Sonar, Alarms, and Set-Up.

These options allow you to customize navigation and sonar settings. Press the MENU button to display the Main Menu Bar, once the Main Menu Bar is on-screen, the Menu button is used to toggle between the five Main Menu Bar options. Each selection made on the Main Menu Bar displays a list of menus.

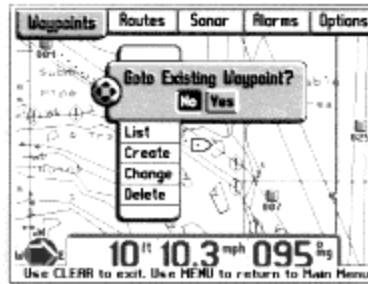

Use the cursor to select individual menus and make adjustments. Some menus link to sub-menus. To return from a sub-menu, press MENU, or to exit the menu system press CLEAR. Changes made to the menu system are saved as the setting is adjusted.

Waypoints

A waypoint is a specific location, such as a buoy or wreck, that you may want to return to in your navigation. The NS25 stores up to 250 permanent waypoints and 50 temporary (lost at power off) waypoints. The waypoint menus allow you to navigate to waypoints, and list, create, change or delete waypoint information. Pressing CLEAR when finished with any waypoint option saves entries and returns to the map view. You may select Show in some menus to display your present position relative to the selected waypoint in a map view.

Note: The coordinate system selected in the Set-Up option of the Main Menu Bar determines the coordinate system for Waypoint menus.

Select Waypoints from the Main Menu bar to access all waypoint options.

To Go to an existing waypoint:

1. Highlighting GoTo, select Yes to display waypoint list.

The waypoint list displays all temporary and permanent waypoints in a sequence. An information box displays the pertinent information for each selected waypoint.

Note: The initial option in the waypoint list is "List By". Select this option to display waypoint by number (factory setting), name, symbol, date, or distance.

2. Use cursor to select destination waypoints from list, then select GOTO. You may select multiple waypoints in the sequence you wish to travel. Each selected waypoint is assigned a sequential number to identify its place in the temporary route. You may deselect a waypoint by highlighting a flagged waypoint, then selecting the “?” icon.

To list existing waypoints:

1. Highlight List, select Yes to display Waypoint List.
2. The first waypoint listed displays in the active menu, scroll down the list to make other selections and view waypoint information. Select Show to display the waypoint and your present position on a map.

To create a new waypoint:

1. Highlight Create, then select Yes to display the Create Waypoint screen.
2. The Enter Latitude menu displays. Scroll through the number fields to enter appropriate numbers, then select OK when finished.
3. The Enter Longitude menu displays. Scroll through number fields to enter appropriate numbers, then select OK when finished.

Note: Using the Clear or Menu key to exit at this point will save waypoint information.

4. The Enter Name menu displays. Scroll through letter fields to name the waypoint (name is limited to 16 characters), then select OK when finished.
5. The Select Symbol menu displays. Scroll through symbol fields to make a selection, then select OK when finished. Select None if you do not wish to assign a symbol.
6. The Save Waypoint menu displays. Select Yes to save to permanent waypoint list. Select No to cancel and enter information again.

Note: The NS25 will assign a system number to a new waypoint. This number is not always in the sequence in which it was created.

To change an existing waypoint:

1. Highlight Change, then select Yes to display the Change waypoints screen. Scroll through waypoint list to highlight a waypoint. Select Change to initiate procedure.

Note: If the selected waypoint is a temporary waypoint, it becomes a permanent waypoint when selecting Change.

2. The Change Latitude menu displays. Scroll through digits to make changes, if needed. Select OK when finished.

3. The Change Longitude menu displays. Scroll through digits to make changes, if needed. Select OK when finished.
4. The Change Name menu displays. Scroll through letters to make changes, if needed. Select OK when finished.
5. The Change Symbol menu displays. Scroll through symbols to make changes, if needed. Select OK when finished.
6. The Save Changes menu displays. Select No to discard changes, select Yes to save changes.

To delete waypoints:

1. Highlight Delete, then select Yes to display the Delete Waypoints screen.
2. Scroll through waypoint list to highlight a waypoint, then select Delete to mark for deletion.

Note: A waypoint marked for deletion is noted by an "X" next to the waypoint symbol in the list. Waypoints are deleted from memory when you exit this screen.

Routes

Routes link a series of waypoints together to create a path that can be saved and used later. They are comprised of 2 to 50 waypoints and can be traveled in whole or in part, in either direction. There are two types of routes: temporary (up to 10 can be created using the GOTO key), and permanent (up to 20 can be created in the Route menu). You may select SHOW in some menus to display the selected route in a map view.

Select Route from the Main Menu bar to access all route options.

To travel an existing route:

1. Highlight Travel and select Yes to display Travel Existing Route screen with the route list.
2. Scroll through Route List to select a route to travel.
3. Select Travel to travel the existing route. Selecting Travel displays the route sequence list, a detailed list of waypoints within a route. From here the start and end waypoints are designated.
4. From the route sequence list, highlight a waypoint you wish to start from, then select Start to establish it as the first point in the route.

5. Highlight the waypoint you wish to end with, then select End to establish it as the last point in the route.
6. The Route Confirmation screen displays. Select Yes to confirm, select Redo to enter information again.

Note: When you exit this option, the NS25 provides navigation information from your present position to the "Start" waypoint, then it will sequence through waypoints as each is reached.

To list routes:

1. Highlight List, then select Yes to display the List Existing Routes screen with route list.
2. Scroll through the route list to highlight a route and view route information.
3. Press Show to view the route on a map.

To create a new route:

1. Highlight Create, then select Yes to display the Create New Route screen with the waypoint list.
2. Scroll through the waypoint list to select first waypoint in route, select Add #1 to determine this as the first waypoint. Continue adding waypoints in sequence until you reach the last one for your route. For the last waypoint, select End (this displays the Enter Name screen).
3. Scroll through letter fields to enter name, then select OK to display the Save This Route screen. (Select Skip if you do not wish to name the route).
4. Select Redo to recreate the route or Yes to save it.

Note: The NS25 assigns a system number to a new route. This number is not always in the sequence in which it was created.

To modify routes:

1. Highlight Change then select Yes to display the Change Route screen with the route list.
2. Scroll down to select a route.
3. Select Change to edit the route waypoint information.

Note: If the selected route is temporary, it becomes permanent when selecting Change. Any temporary waypoints in the route also become permanent.

4. Selecting Change displays the route sequence list. From this menu you may add a waypoint before another one, or remove an existing waypoint.

5. Select Add Before to add a waypoint before the selected one in the route, select Remove to mark waypoint for removal. Continue down list and repeat as necessary.
6. Once finished, scroll to end of list until End of Route screen displays. Select Add More if additional waypoints are needed at the end of the route. Select Done when route is complete. This displays the Change Name screen.
7. Scroll through letter fields if it is necessary to change the route name, select OK when finished.

To delete routes:

1. Highlight Delete, then select Yes to display the Delete Route screen with the route list.
2. Scroll through list to select a route.
3. Select Delete to mark route for deletion.

Note: A route marked for deletion is noted by an "X" next to the route symbol in the list. Routes are deleted from memory when you exit this screen.

Sonar

Alarms

The NS25 is equipped with audible alarms alerting you to conditions such as off-course navigating, destination arrival, position drifting, shallow water, and fish. The current setting for the alarm displays in the upper right corner of the alarm menu. The NS25 alarms are:

Off-Course Alarm: sounds when Cross Track Error (XTE) exceeds alarm setting. Off course alarm only functions when traveling a route.

Arrival Alarm: sounds when present position is within set range of destination point. Arrival alarm setting for a stationary point.

Drift Alarm: sounds when present position moves beyond alarm setting for a stationary point.

Depth Alarm: sounds when digital depth is equal to or less than the alarm setting. Also sounds a pre-alarm warning to alert you of quickly changing terrain near your alarm setting.

Fish Alarm: sounds when fish or other targets not connected to the bottom are present.

Select Alarms from the Main Menu bar to access alarm options.

To set Off Course Alarm:

1. Highlight Off Course Alarm.
2. Select ON to activate the alarm. The factory setting is .1NM.
3. Select Adjust to change the numeric alarm setting.

4. The Adjust Off Course menu displays. Scroll to a setting from .01NM to 1NM.

Note: the alarm setting is saved immediately.

To set Arrival Alarm

1. Highlight Arrival Alarm
2. Select ON to activate the alarm. The factory setting is .1NM.
3. Select Adjust to change the numeric alarm setting.
4. The Adjust Arrival Alarm menu displays. Scroll to a setting from .01 to 1NM.

Note: the alarm setting is saved immediately.

To set Drift Alarm:

1. Highlight Drift Alarm
2. Select ON to activate the alarm. The factory setting is .1NM.
3. Select Adjust to change the numeric alarm setting.
4. The Adjust Drift Alarm menu displays. Scroll to a setting from .01NM to 1NM.

Note: the alarm setting is saved immediately.

To set Depth Alarm:

1. Highlight Depth Alarm.
2. Select On to activate the alarm. The factory setting is 15 ft.
3. Select Adjust to change the alarm setting.
4. The Adjust Depth Alarm menu displays. Scroll to a setting from 2 to 99 feet.

Note: the alarm setting is saved immediately.

To set Fish Alarm:

1. Highlight Fish Alarm.
2. Select On to activate the alarm. The factory setting is set to alarm on all fish symbols.
3. Select Adjust to change the alarm setting.

4. The Adjust Fish Alarm menu displays. Highlight the fish symbol to sound the alarm.

Note: the alarm setting is saved immediately.

Set-Up

The NS25 allows you to customize many features to work best for a particular use. The unit remembers these settings after power is disconnected. Listed below are descriptions and steps for Set-Up options.

Contrast

Contrast adjusts the lightness and darkness of the screen to accommodate for outdoor lighting conditions.

To set Display Contrast

1. Highlight Display Contrast
2. Elect desired setting from -5 to +5. The factory setting is zero.

Units-Speed

Units Speed sets the units of measure your speed displays in, i. e., mph, or kts (knots).

To set Units Speed:

1. Highlight Units-Speed
2. Select mph or kts. The factory setting is kts.

Units-Distance

Units Distance sets the units of measure your distance displays, i.e., statute mile (sm) or nautical miles (nm).

To set Units-Distance

1. Highlight Units-Distance.
2. Select sm/ft or nm/ft. The factory setting is nm/ft.

Time

Time determines the format in which the current time will display, i.e., UTC or Local.

To set Time:

1. Highlight Time.
2. Select UTC, or Local. The factory setting is UTC. If Local is selected, select Set Local to set the clock.
3. To set local time, select am, pm, or 24th.
4. Scroll to select appropriate time.

Note: Only hours are adjustable.

5. Select OK to set time.

Coordinate System

Coordinate System determines the format in which your position is displayed.

To set Coordinate System:

1. Highlight Coordinate System.
2. Select appropriate coordinate format. The dd.mm.mmm setting is the factory setting. If Loran TD's is selected, then select Set-Up. The Loran Set Up screen displays.
3. Select the appropriate Group Repetition Interval (GRI) for your area of operation.
4. Highlight Secondary 1. Select a secondary station.
5. Highlight Secondary 2. Select a secondary station.

Note: Loran TD's cannot be directly entered when using the waypoint menus. The position entry options will be difficult to Latitude and Longitude when Loran TD is selected.

North Reference

North Reference determines the course and bearing calculations, relative to true magnetic north.

To set North Reference:

1. Highlight North Reference.
2. Select True or Magnetic. The factory setting is True.

Map Datum

Map Datum selects the geodetic datum for drawing the map.

CAUTION: This setting must match the datum used to create the map. Typically, this setting does not need to be adjusted.

To set Map Datum

1. Highlight Map Datum.
2. Select the datum for the map, the factory setting is WGS 84. If Custom is selected, then select Set-Up. The custom Datum Set-Up menu displays.
3. Select the appropriate Ellipsoid, DX, DY, and DZ values.

Note: Make sure your settings for the custom datum match the map source.

Course History

Course History sets the time intervals used to plot the course history trail. This is represented by a trail of squares.

To set Course History:

1. Highlight Course History.

2. Select an interval ranging from 1-15 seconds. The factory setting is 5 seconds.

Note: The larger the interval, the more distance you can cover with the course history trail.

Assign IPL's (information Priority Levels)

Assign IPL's sets the priorities for objects drawn on-screen. See "Views- Customizing the Display" for more information.

To set IPL's:

1. Select Yes to display the Assign Priority Level menu.
2. Scroll through the objects list to select an object, then assign it a priority level 1-7. Continue scroll through the objects list to prioritize objects for display according to your preference.

Land-Water

Land-Water inverts the colors for land and water on screen.

To set Land-Water:

1. Highlight Land-Water.
2. Select Normal or Inverted to set the shading for features on the map. The factory setting is Normal.

Depth Offset

Depth Offset modifies the digital depth readout to display depth from either the waterline or the keel. Select a positive number equal to the vertical distance between the transducer and waterline for depth at the waterline; or select a negative number equal to the vertical distance between the transducer and keel for depth at the keel.

To set Depth Offset:

1. Highlight Depth Offset.
2. Select a setting ranging from -10 to +10 to adjust the depth difference. The factory setting is 0.

Map Offset

Map Offset accommodates localized regions where there is a present offset in the map with respect to your present position. The offset is due to a shift in the database used to generate the digitized maps. Entering an off-set distance with respect to your position moves the map to the correct position.

To set Map offset:

1. Highlight Map Offset.
2. Select On, then Adjust. Your present position displays on a map.
3. Move the cursor to the correct location of your present position and press CLEAR to save and exit.

DGPS Baud Rate

Set the DGPS Baud Rate to correspond to an optional differential beacon receiver's output rate.

To set DGPS Baud Rate:

1. Highlight DGPS Baud Rate.
2. Select 4800 or 9600.

Reset Unit

Reset Unit restores all features to factory settings.

To Reset Unit:

1. Highlight Reset Unit.
2. Select Yes to reset all user features to original settings.

Delete All Waypoints

Delete All Waypoints deletes all waypoints and routes stored in memory.

To Delete All Waypoints:

1. Highlight Delete All Waypoints.
2. Select Yes to delete all waypoints and routes.

Simulator Location

Simulator Location sets the center point of the simulator track.

To set Simulator Location

1. Highlight Simulator Location
2. Select Custom, Then Set-Up to display the current simulator position on screen.
3. Move cursor to area intended for simulation, press CLEAR to save and exit.

Connecting the NS25 to Optional Devices

NMEA

The NS25 can relay position, speed and course information to an autopilot or other NMEA device. The NS25 uses a standard format for computing this information called an NMEA 0183 (v2.0). This standard is defined by the National Marine Electronics Association, and is commonly used by most marine electronics manufacturers. The output comes from the “Y” cable at the control head. It broadcasts this information out in APB (Autopilot Sentence “B”, contains navigation receiver warning flag status, cross track-error, waypoint arrival status, initial bearing, and continuous bearing) and BWR (time and bearing to, and location of, a specified waypoint from present position) sentences.

The wire connectors are output “talk” only. The red wire is the signal (NMEA line “A”) and the black wire is ground (NMEA line “B”).

DGPS

The NS25 is compatible with DGPS (Differential Global Positioning System), which uses radio tower signals to enhance position accuracy. These signals are available in select areas, check your area of operation for DGPS coverage.

DGPS input uses an RS-232 serial connection and accepts data in the RTCM SC-104 data format. It is compatible with Communications System International (CSI) model MBX-2 and Magellan model DBR.

The red wire is used for signal and the black wire is used for ground.

The NS25 should be set at a baud rate of 4800 or 9600 (default), whichever is compatible with your Differential Beacon Receiver. This setting is made in the Set-Up menu (see “Using the Menu” – Set-Up for more information).

If connected, check DGPS field in the System Status view to confirm unit is receiving correction signal. If “NONE” displays in the field (indicating that it is not receiving), try toggling between both baud rates and check connections. Refer to your DGPS manual for further instructions.

Maintenance and Warranty....

Specifications

Sonar

Operating Frequency 200 kHz

Power Output 300 Watts (RM)
 2400 Watts (Peak to Peak)

Transducer Single Beam: XT-6-20

Area of Coverage 20 degrees @ -10db

Depth Capability 1000 feet

Cable Length 20 feet

Control Head

Display Type FSTN 4 Level Grayscale

Display Size 3.40" V x 4.53" H

Display Matrix 240 V x 320 H

Backlight Electroluminescent (EL)

Mounting Quick Disconnect or In-Dash

Construction High Impact Polycarbonate with Silicone Gasket

Dimensions 7.5/8 " h x 7 7/8" w x 4 3/8" d

GPS Receiver

Channels 12 Parallel

Antenna Type Passive Patch

Cable Length 20 feet (included)

Mounting Socket 1" – 14 Standard Marine Thread

Construction High Impact Polycarbonate with Silicone Gasket

Dimensions 3 1/8" h x 3 3/8" w x 4 1/16" d

C-card Reader

Map Format C-Map NT

Cards Accepted 2

Cable Length 6 feet

Communication

NMEA	V2.0 Output Only Sentences Supported: APB, BWR
DGPS	Input: RS-232, RTCM SC104 Data format. 4800/9600 Baud (Magellan DBR, CSI MBX-2)

Memory

Waypoints	250 Permanent, 50 Temporary
Routes	20 Permanent, 10 temporary
Course History	1000 Points

Power

Voltage Input	10 – 16 VDC
In-Line Fuse	1. 5-Amp Slow-Blow
Power Consumption	4. 5 watts @ 13 VDC (Backlight Off) 7 watts @ 13 VDC (Backlight On)

Glossary

CLEAR

Deletes temporary waypoints, course history, and routes, Also turns off activated alarms.

COURSE

Actual direction of travel measured in degrees from North.

CURSOR

Cross-hair line in map views used to interact with on-screen information.

COURSE HISTORY

A course history line is shown in the graphics area, attached to the present indicator. This shows the history for your course, or where you have been. It shows the history for your course, or where you have been. It is helpful in visualizing the progress, or retracting your course to return to the starting point.

DD degrees MM>MMM

Displays position coordinates in Latitude/ Longitude showing degrees (DD degrees) and decimal minutes (MM.MMM). This provides a highly accurate position readout.

DD degrees MM' SS"

Selects position readout in Latitude/Longitude showing degrees (DD degrees), minutes, (MM'), and seconds (SS"). This is the traditional but less precise method of coordinate display.

GO TO

Creates a temporary route to a point selected.

KNOT

Nautical mile per hour. The normal measurement of speed for boats, expressed relative to nautical miles instead of statute miles.

LORAN

Long Range Radio Navigation. It is a series of chains of ground-based transmitters located along coastal areas world-wide. Loran receivers receive transmitted pulses from a master station and two secondary stations, and use TD's (select position readout in Time Differentials) between pulses to calculate its position relative to the transmitters.

MAGNETIC NORTH

The natural magnetic pole of the earth. This point is continually moving over time, and differs from true north by several hundred miles. This is the point to which all magnetic compasses will point.

MAP DATUM

A datum is an initial set of numeric geometrical quantities used as a reference from which to measure other quantities used to define a region. From this information a map is created. The NS25 allows you to choose from a selected list of map datums or it will default to the most commonly used map datum in your area.

NAUTICAL MILE

Unit of distance with one nautical mile equating one minute of latitude at the equator or about 6,000 feet.

NIMA INTERFACE (OUTPUT)

This communicate with autopilots, plotters, radar etc. The National Marine Electronics Association has developed a standard for communication between electronic navigation instruments.

POSITION

There are two options available for the display of your position: LAT LON is the default setting., it provides your position with reference to the standard coordinate positioning of latitude and longitude. The other option is "Lorans". It allows position read-outs in reference to Loran stations, the same way that Loran receivers work. The readout is in "time differentials" (TD's). This feature is designed to appeal to long time users who have stored points of interest by reference to TD's. While the NS25 can be configured to read-out in TD's, be aware that doing so requires a complete understanding of the loran system, and the accuracy of position readouts is limited to the accuracy of both the loran system and the receiver used to store the points.

POWER

Press POWER once to turn on the NS25. To turn it off, hold down the key for three seconds, until the audible chirp is heard. This will prevent accidentally turning the unit off during normal operation.

P-STOR

Stores your preset position as a temporary waypoint, or stores the position of the cursor when it is in use.

ROUTE

A series of waypoints stored for navigating to a specific location.

TD's

Time differentials from Loran stations.

UTM

Selects position readout in Universal Transverse Mercator, the coordinate system used by some maps (such as USGS topographic maps).

WAYPOINT

A point of interest stored and included in routes.

XTE

Cross Track Error. The XTE is the distance between your position and the desired route.

